

INLINE EXTENDABLE PIVOT

MODEL:CT8001/CT8006

INSTALLATION INSTRUCTION

IMPORTANT NOTICE:

- Before the installation process begins, ensure that all components are in the box, and that the door is not damaged in any way .
- Be careful when moving the product, especially the glass, as it is tempered and is designed to shatter if cracked or chipped.
- Read these instructions carefully and install the enclosure as specified below. We recommend that you use one of our preferred installers to install this enclosure.

Tools Required:

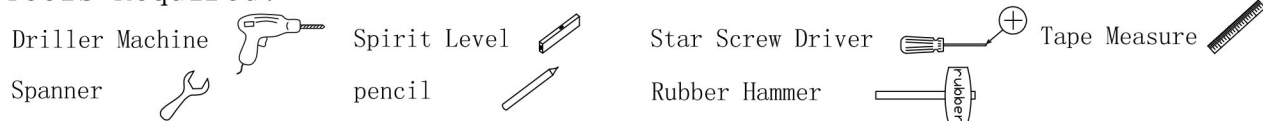

• Accessories list

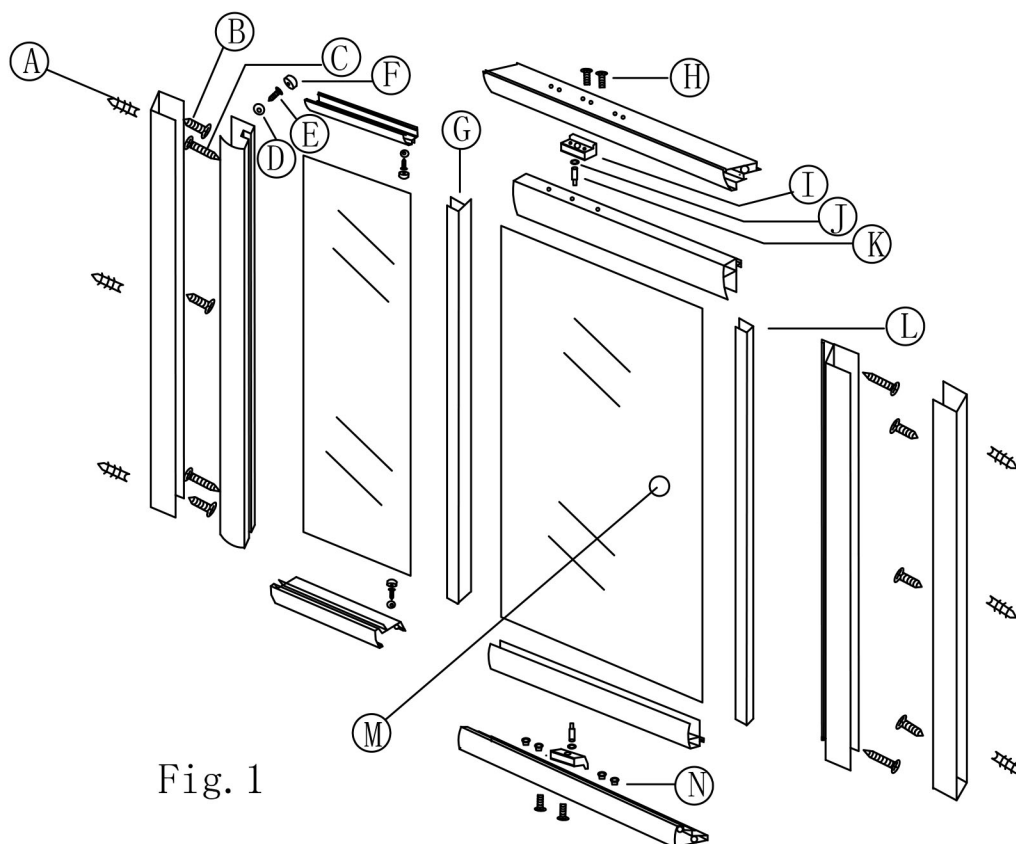

N. O.	PART NAME	QUAN	N. O.	PART NAME	QUAN	N. O.	PART NAME	QUAN
A	WALL PIUG	6	F	DECORATIVE COVER	6	K	PIVOT	2
B	H4. 2*32 SCREW	6	G	RUBBER SEAL	1	L	MAGNETIC SEALS	2
C	H3. 9*32 SCREW	6	H	H5X16 PIVOT SEREW	4	M	HANDLES	1
D	SCREW COVER	6	I	PIVOT SUPPORT	2	N	CAP OF PIVOT	8
E	H3. 9*13 SCREW	6	J	PIVOT SUPPORT	2			

FIG 2: FIX SIDE SECTIONS

Attach wall profile to each side of the wall using supplied wall screws and plugs. Use silicone sealer to seal each profile on the inside of the shower enclosure.

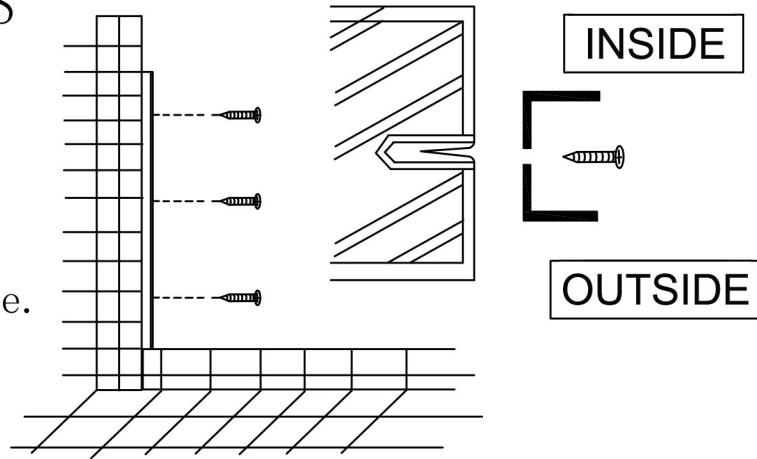

Fig. 2

Fig. 3

After you have assembled the enclosure you must first slide the enclosure into the one wall profile, then extend the enclosure to desired length and slide into the other wall profile.

Secure enclosure into position using grub screws and decorative covers.

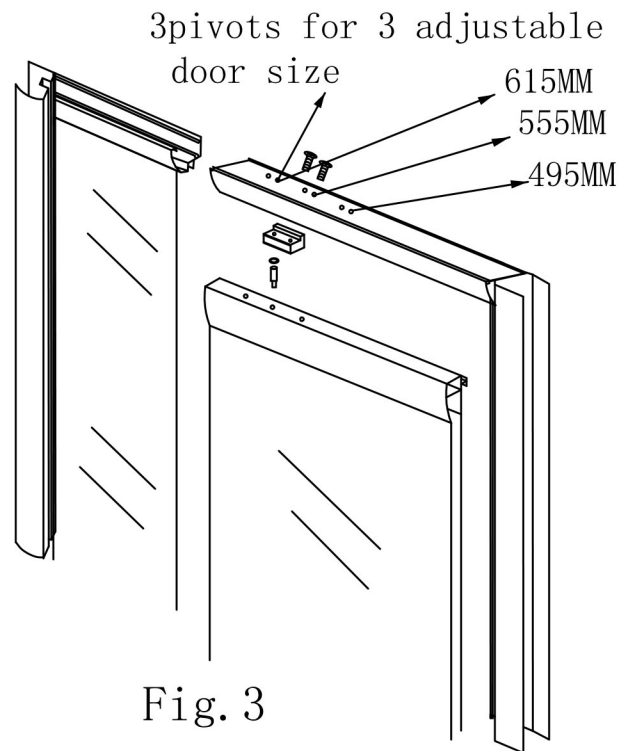

Fig. 3

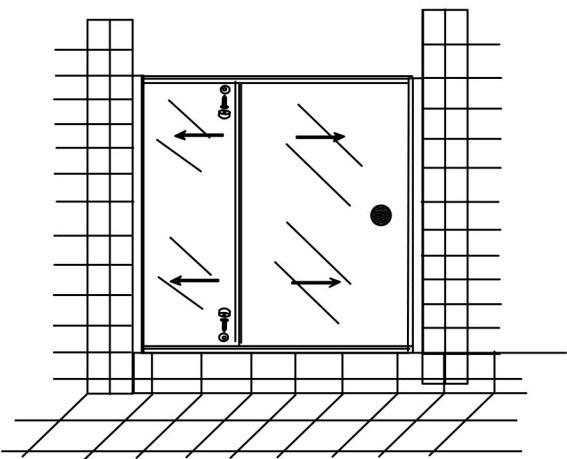
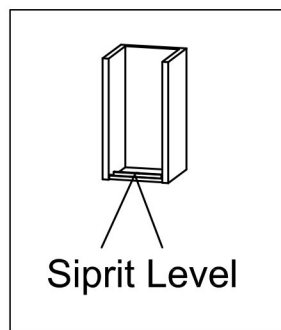

Fig. 4

Fig. 4

Once shower is installed use silicone to seal all exposed areas. Allow to dry for at least 12 hours. Do not use abrasive cleaning materials.

Installing CT8001(800-100)/CT8006(1000-1200)between two walls



1. Ensure that the floor/tray is level before you begin with the installation.

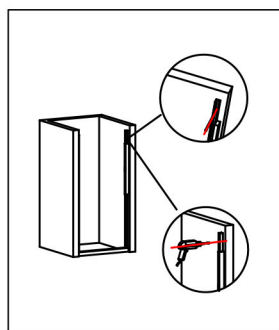

2. Ensure that you use a spirit level to make sure that the wall channel is completely plumb before you mark and drill the holes.

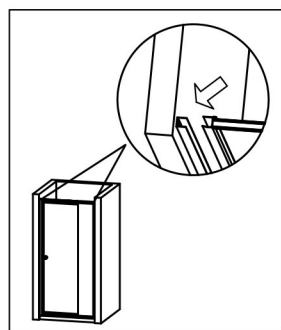

3. Insert door panel.

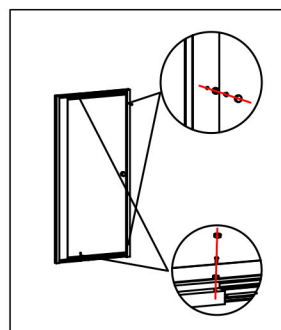

4. Once the enclosure is in place and the profiles are correctly placed over the wall channels, you can fix the enclosure in place through supplied screws and decorative caps.

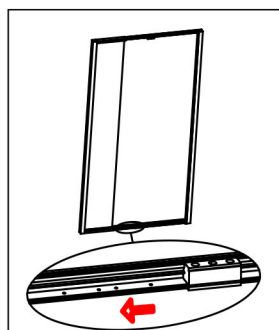

5. To obtain the bigger open distance through moving the pivot position if the distance is allowed.

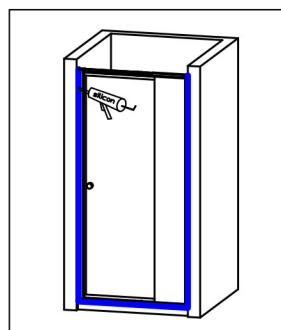

6. You now need to seal the enclosure with a good anti fungal silicone, only seal the out side of the enclosure. DO NOT SEAL THE ENCLOSURE ON BOTH SIDES!

Installing shower with a return panel 8002 (800 - 1000).

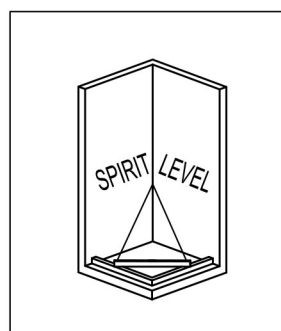

1. Ensure that the floor/tray is level before you begin with the installation.

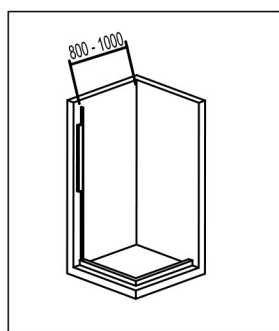

2. Ensure your size is between 800-1000mm.

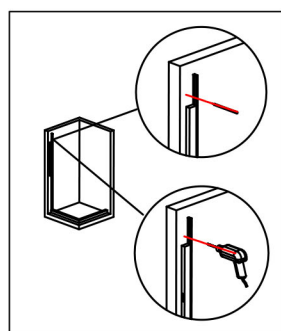

3. Ensure that you use a spirit level to make sure that the wall channel is completely plumb before you mark and drill the holes.

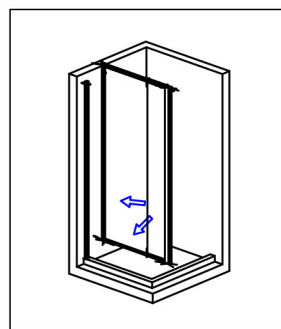

4. Insert return panel.

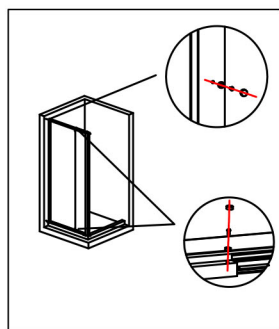

5. Adjust size to your wanted and fix the return panel into place. The follow is the same instructions as installing between two walls.



6. Allow the enclosure to dry for at least 24 hours before making use of it.